

Gerätetypen / Recorder Models / Type d'appareil

Ersatzteil-Nr. Manufacturer Part-Number Réf. Constructeur	Farben	Colours	Couleurs	DIA-Nummer DIA-Part-Number Référence DIA
FESCH 11/1	blau	blue	bleu	F51046 -03Z-05
FESCH 11/2	rot	red	rouge	F51046 -02Z-05
FESCH 288/5				W10206
FESCH 2/4/71				W10209

F51271 / x = 9,2

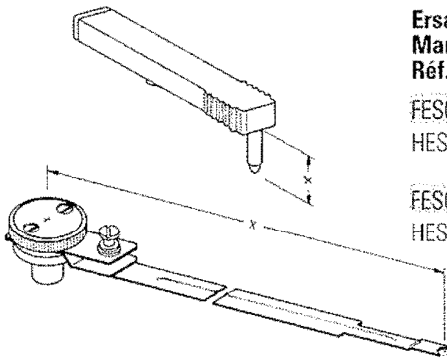

W10193 / x = 82,5
W10194 / x = 135,0

Gerätetypen / Recorder Models / Type d'appareil

NG 180, NG 300

Ersatzteil-Nr. Manufacturer Part-Number Réf. Constructeur	Farben	Colours	Couleurs	DIA-Nummer DIA-Part-Number Référence DIA
FESCH 10/1	blau	blue	bleu	F51271 -03Z-05
HESCH 180/1				W10193
FESCH 10/1	blau	blue	bleu	F51271 -03Z-05
HESCH 300/1				W10194

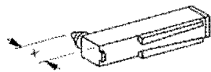

F51639 / x = 8,5

Gerätetypen / Recorder Models / Type d'appareil

KRK 501, KRK 508

Ersatzteil-Nr. Manufacturer Part-Number Réf. Constructeur	Farben	Colours	Couleurs	DIA-Nummer DIA-Part-Number Référence DIA
A 07604.0002	blau	blue	bleu	F51639 -03Z-05

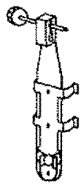

W20178

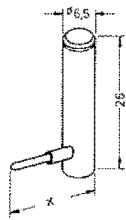

F51002H / x = 17,5

Gerätetypen / Recorder Models / Type d'appareil

RB...

Ersatzteil-Nr. Manufacturer Part-Number Réf. Constructeur	Farben	Colours	Couleurs	DIA-Nummer DIA-Part-Number Référence DIA
				F51002H-**-Z-05 W20178
	lieferbar 01 - 06	available 01 - 06	disponibles 01 - 06	

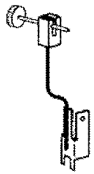

W10130

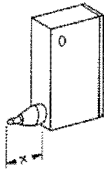

F51046 / x = 6,5

FESCH 11/1	blau	blue	bleu	F51046-03Z-05
FESCH 11/2	rot	red	rouge	F51046-02Z-05
				W10130

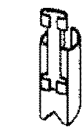

W20153

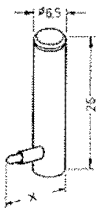

F51002C / x = 13,0

Gerätetypen / Recorder Models / Type d'appareil

Ersatzteil-Nr. Manufacturer Part-Number Réf. Constructeur	Farben	Colours	Couleurs	DIA-Nummer DIA-Part-Number Référence DIA
FESCH 12/1	blau	blue	bleu	F51002C-03Z-05 W20153

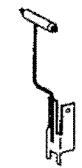

W10110

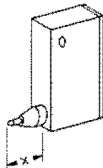

F51046 / x = 6,5

Gerätetypen / Recorder Models / Type d'appareil

Ersatzteil-Nr. Manufacturer Part-Number Réf. Constructeur	Farben	Colours	Couleurs	DIA-Nummer DIA-Part-Number Référence DIA
FESCH 11/1	blau	blue	bleu	F51046-03Z-05
FESCH 11/2	rot	red	rouge	F51046-02Z-05
				W10110